

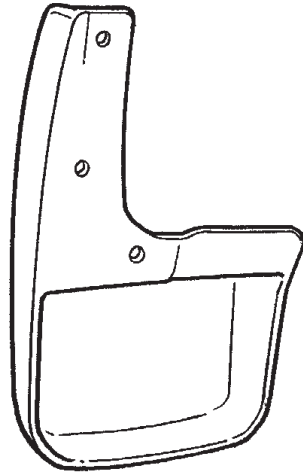

JEEP / LIBERTY

Rear Splashguard

Rear Right



A

Rear Left

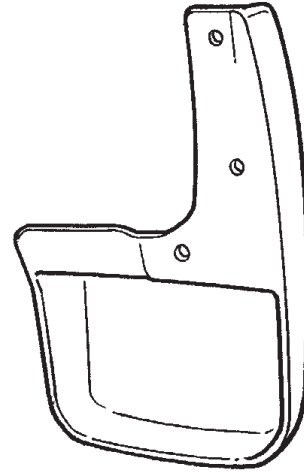

B

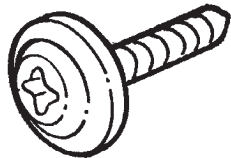

C 8X

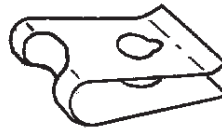

D 2X

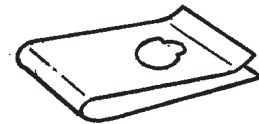

E 4X

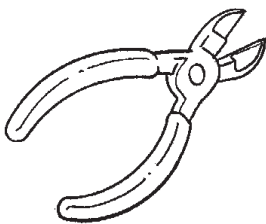

3/32" (2.5 mm)



#2 Phillips
Screw Driver

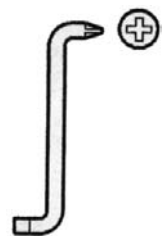

#2

1

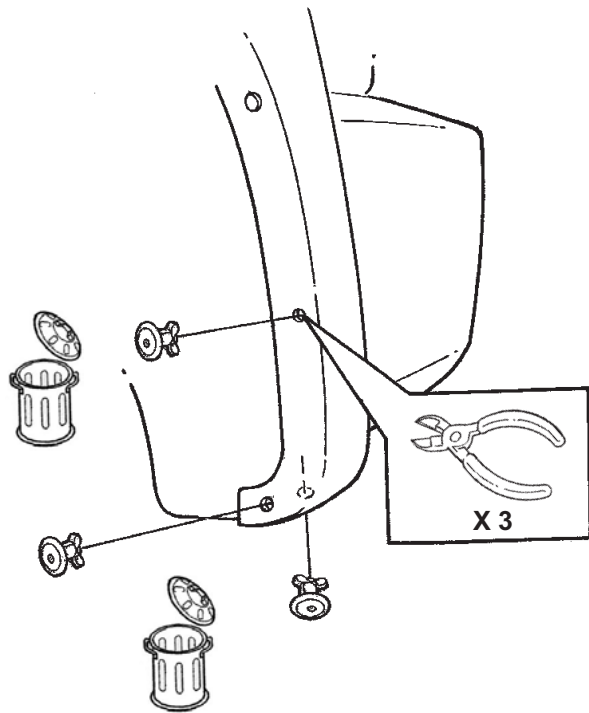

2

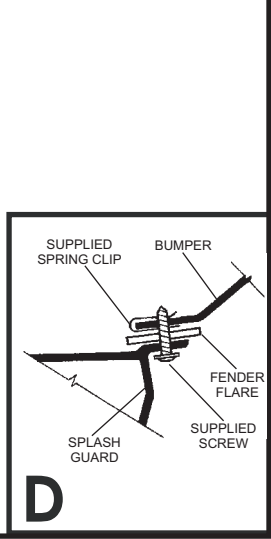
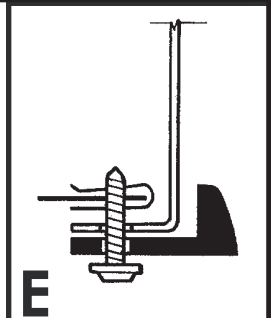
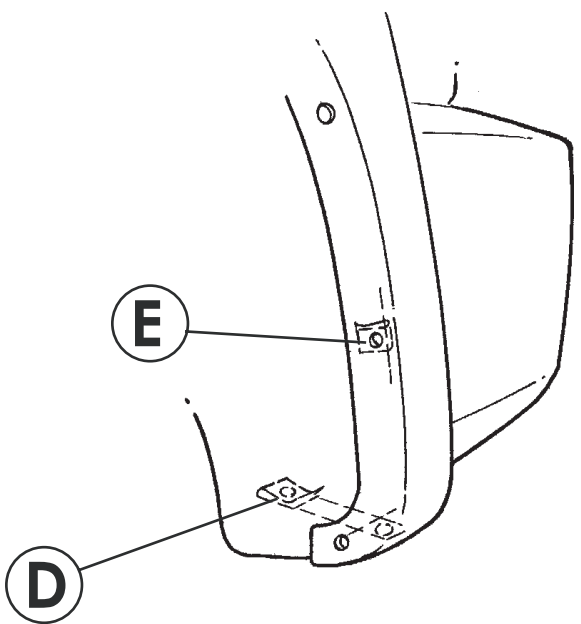

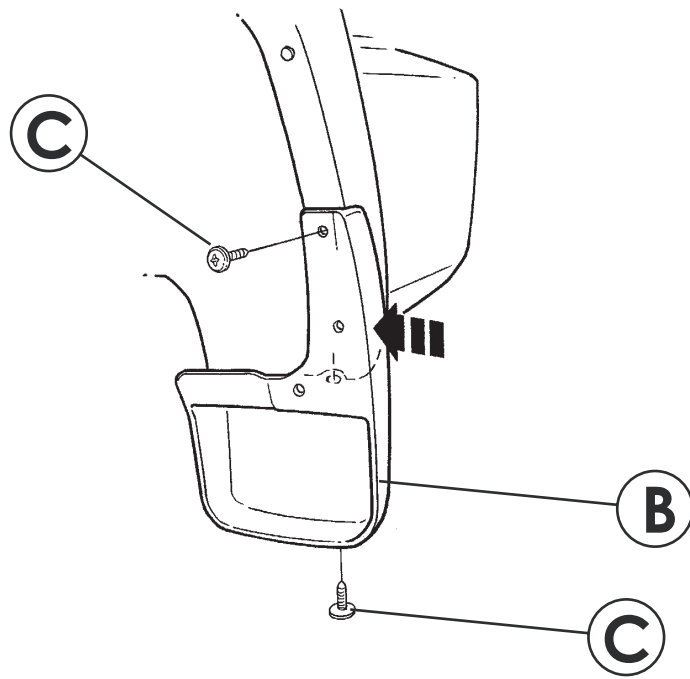

3

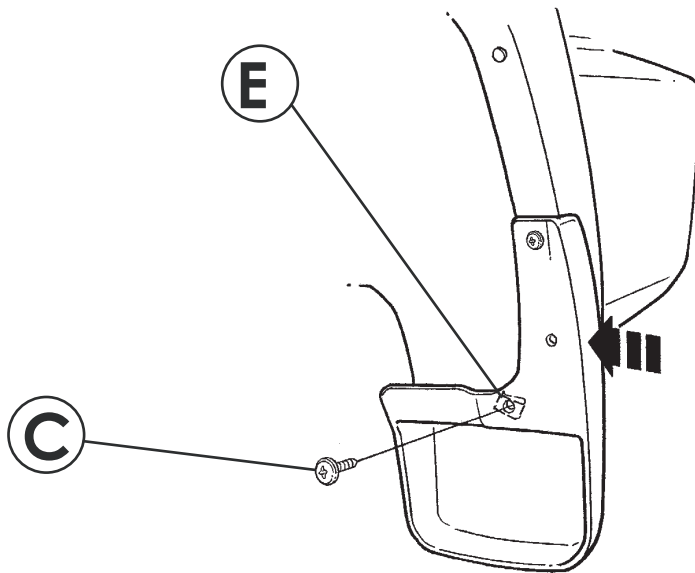

4

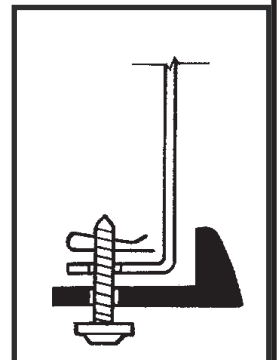

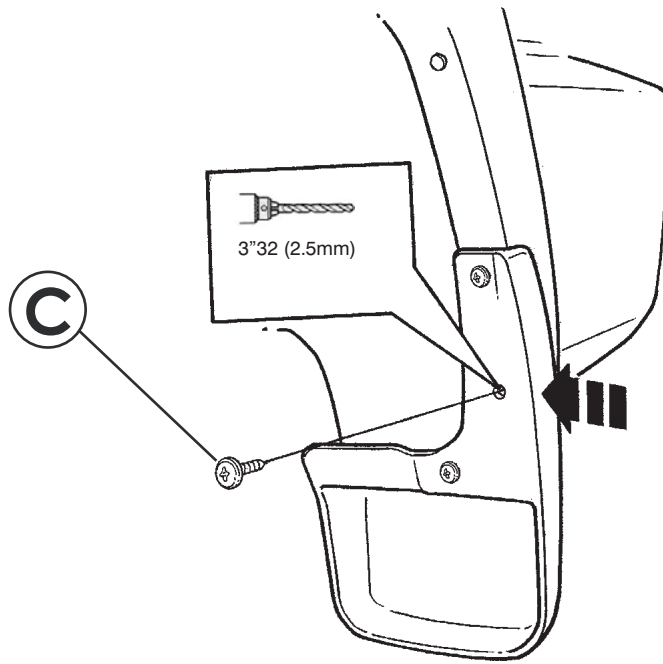

5